

RF-35HTC



Your Dreams, Our Challenge

High Thermal Conductivity Laminate

Benefits

- Best in Class Thermal Conductivity
- Low Loss Tangent
- No Glass Reinforcement
- Resists Thermal Oxidation
- High Dimensional Stability

Applications

- High power applications such as filters, Couplers, Dividers & Power amplifiers
- Antennas
- Satellites

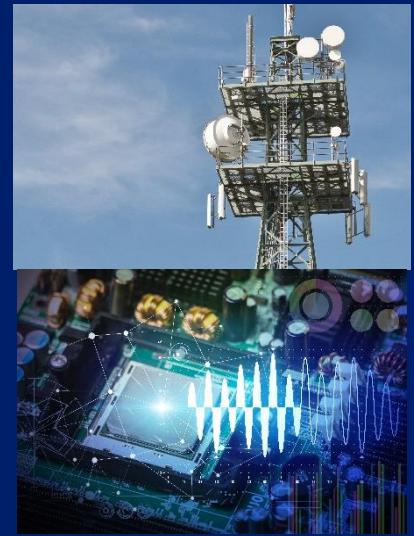

RF-35HTC is a non-reinforced, low loss, industry leading thermally conductive laminate. The high 1.84 watts/M*K thermal conductivity is well suited for any high-power application including amplifiers, couplers, dividers, filters etc. RF-35HTC is a ceramic/PTFE composite that is very low in PTFE content. The extremely low loss of 0.0007 at 10 GHz makes RF-35HTC very attractive for any high-power application.

The high thermal conductivity is beneficial for moving localized heat away from transistors, capacitors, conductors, other components, or the dielectric material. In hot environments exposed to oxygen, hydrocarbon (synthetic rubber) based composites are prone to oxidation and higher than expected electrical/thermal losses predicted from modeling. PTFE is attractive at the highest of temperatures because PTFE resists any thermal oxidation.

Uniform distribution of ceramic in the dielectric ensures a uniform dielectric in the X, Y, and Z directions. The low X and Y CTE ensures good performance of filters over temperature. The low Z axis expansion ensures stable performance of narrow band or broad band couplers over temperature and stable signal to ground plane dielectric thickness (stable impedance) over temperature. The low PTFE content of RF-35HTC facilitates plating and drilling in printed circuit board fabrication. The high concentration of ceramic contributes to improved dimensional stability. AGC has avoided the use of alumina that is abrasive to mechanical drilling or routing.

Power handling experiments were conducted on microstrip transmission lines with and without various capacitors at the center of the microstrip to quantify the capability of the dielectric to spread thermal energy. The heat profile of the microstrip, both with and without a capacitor, and any hot spots was captured using a thermal camera. Transmitted power was increased to 200 Watts. AGC's RF-35HTC was compared to AGC's RF-35TC and RF-35TC-A, as well as to two available competitive materials. In every case, the RF-35HTC dielectric material outperformed all other materials in its ability to spread thermal energy, as shown on page 2.

RF-35HTC is compatible with all AGC 1 oz copper with ULP 1 oz copper being recommended at high frequencies for the lowest insertion losses. Please consult with your technical sales manager about which coppers are most suitable for your application when using 1/2 oz copper.

Power Handling Test Configuration for Various Laminate Materials

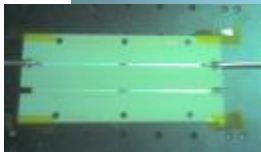

**Material ; 20mil / 1 oz
Circuit width ; 1.08mm
Circuit length ; 120mm
Capacitor ; 47pF**

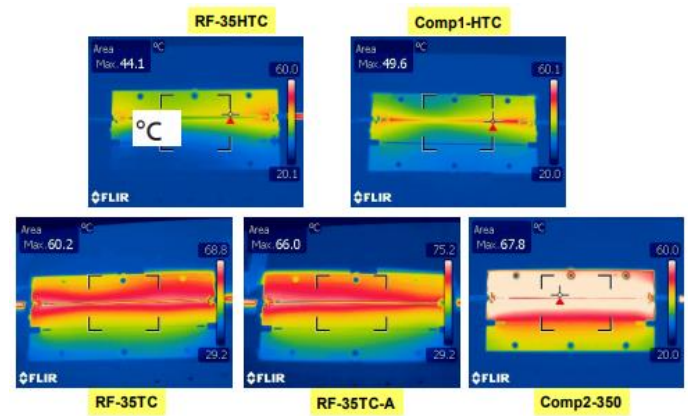
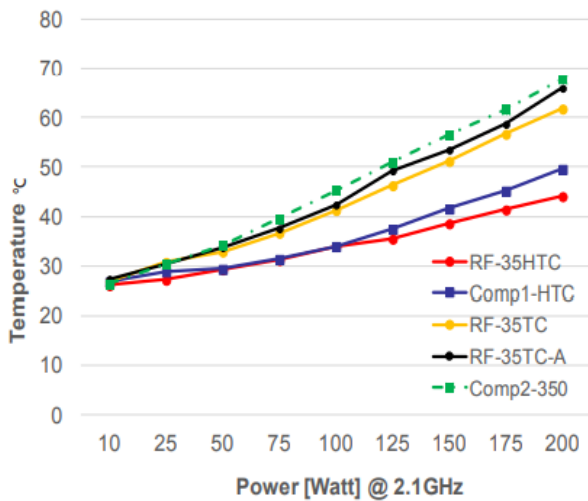
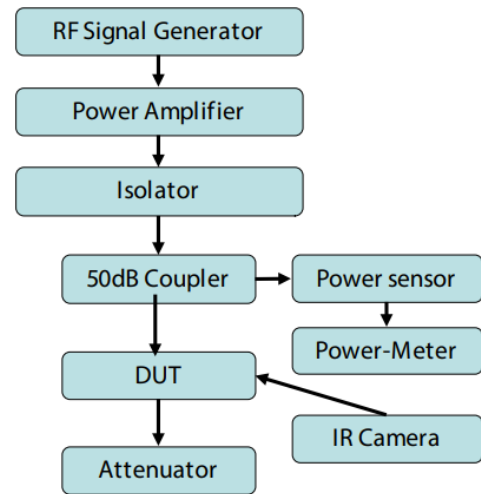

Power Handling of Microstrip Circuits Having No Capacitor (tin finished)

Thermal Camera Imaging of Microstrip Circuits, Tin Finished, No Capacitor (20 mil DT, 1oz Cu, 200 watts, 2.1 GHz)

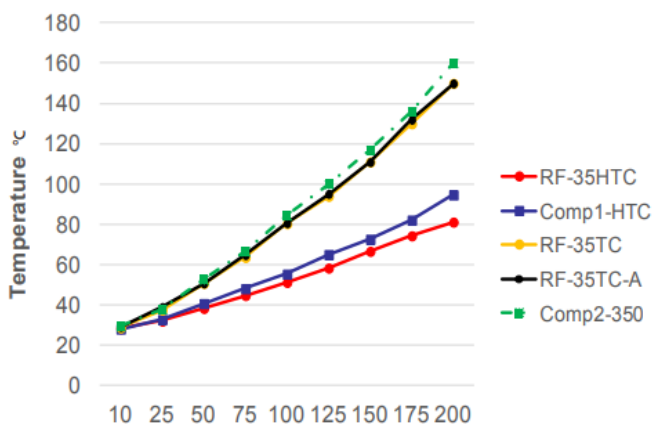

Power Handling of Microstrip Circuits Containing a COG Grade 47 pF High Q Capacitor by Murata

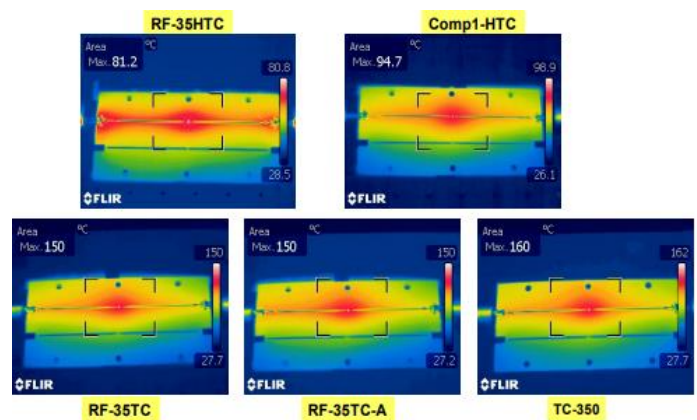

Thermal Camera Imaging of Microstrip Circuits Having a 47 pF Murata Capacitor (20 mil DT, 1oz Cu, 2.1 GHz, 200 Watts)

Properties	Conditions	Typical Value	Unit	Test Method
Electrical Properties				
Dielectric Constant	@ 10 GHz	3.50 ± 0.05		IPC-650 2.5.36
Dissipation Factor	@ 10 GHz	0.0007		IPC-650 2.5.36
Volume Resistivity		1.7 x 10 ⁹	Mohms/cm	IPC-650 2.5.17.1 (After elevated temp.)
Surface Resistivity		2.9 x 10 ⁶	Mohms/cm	IPC-650 2.5.17.1 (After humidity)
Thermal Properties				
Thermal Conductivity	Unclad	1.84	W/M*K	ASTM F433, ASTM E1461 (Laser Flash)
	clad	2.89	W/M*K	
CTE (23 to 125 °C)	X	11	ppm/°C	IPC-650 2.4.41 / ASTM D 3386
	Y	14		
	Z	77		
Mechanical Properties				
Peel Strength	1 oz. CL1	1.08 (6.17)	N/mm (lbs/in)	IPC-650 2.4.8 (Thermal Stress)
Flexural Strength	Lengthwise	18.4 (2,670)	MPa (psi)	ASTM D 790 / IPC-650 2.4.4
	Crosswise	17.7 (2,560)	MPa (psi)	
Tensile Strength	Lengthwise	6.6 (957)	MPa (psi)	ASTM D 3039 / IPC-TM-650 2.4.19
	Crosswise	6.2 (899)	MPa (psi)	
Elongation at Break	MD	4.1	%	ASTM D 3039 / IPC-TM-650 2.4.19
	CD	9.9	%	
Young's Modulus	MD	2,856 (414,228)	MPa (psi)	ASTM D 3039 / IPC-TM-650 2.4.19
	CD	2,676 (388,121)	MPa (psi)	
Poisson's Ratio	MD	0.08		ASTM D 3039 / IPC-TM-650 2.4.19
	CD	0.08		
Dimensional Stability	MD	-0.01	mm/M (mils/in.)	IPC-650-2.4.39 Sec. 5.4 (After Etch)
	CD	-0.01	mm/M (mils/in.)	
Dimensional Stability	MD	-0.05	mm/M (mils/in.)	IPC-650-2.4.39 Sec. 5.5 (Thermal Stress)
	CD	-0.02	mm/M (mils/in.)	
Chemical / Physical Properties				
Dielectric Breakdown		42	kV	IPC-650 2.5.6
Moisture Absorption		0.07	%	IPC-650 2.6.2.1
Arc Resistance		> 400	seconds	IPC-650 2.5.1
Hardness		60.2	%	ASTM D 2240 (Shore D)

Panels may be ordered cut to size

Inches	mm	Inches	mm
12 x 18	304 x 457	16 x 36	406 x 914
16 x 18	406 x 457	24 x 36	610 x 914
18 x 24	457 x 610	18 x 48	457 x 1,220

Typical Thickness

Inches	mm
.0050, 0.0100, 0.0200	0.13, 0.25, 0.51
.0300, 0.0600, 0.0900	0.76, 1.52, 2.29

Thickness Tolerance

Thickness Availability

mil	mm	mil	mm
Class C	Class C	Incr. of 5	Incr. of 0.127

- * All test data provided are typical values and not intended to be specification values. For review of critical specification tolerances, please contact a company representative directly.
- * RF-35HTC can be manufactured in increments of 0.005"(0.125mm).
- * Standard panel size is 18" x 24" (457 mm x 610 mm).
- * Please contact AGC for availability of additional thicknesses, other sizes & any other type of cladding.

